

Specification

3250II THERMAL RECEIPT PRINTER

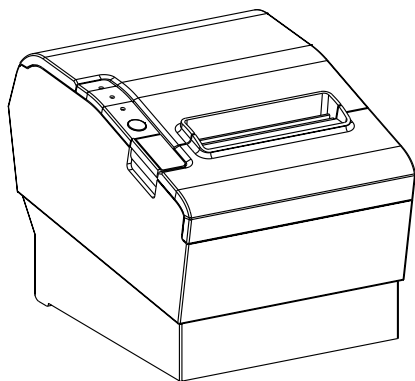

Proficient in Commercial POS Receipt Printers

1. Safety Notice:

- * Don't touch the printer head with anything.
- * Don't touch the cutter blade.
- * Don't bend the power cord excessively or place any heavy objects onto it.
- * Don't use the printer when it is out of order. This can cause a fire or and electrocution.
- * When connecting or disconnecting the plug, always hold the plug but not the cord.
- * Keep the desiccant out of children's reach.
- * Use only approved accessories and do not try to disassemble, repair or remodel it by yourself.
- * Install the printer on the stable surface. Choose firm, level surface where avoid vibration.
- * Don't let water or other foreign objects into the printer.
- * Don't connect a telephone line into the peripheral drive connector.
- * We recommend that you unplug the printer from the power outlet if no use it for a long period .

2. Applications:

- * POS system Receipts
- * EFT POS system Receipts
- * Gym, post, hospital, civil aviation system Receipts
- * Inquiry, Service system Receipts
- * Instrument test Receipts
- * Tax, Tab Receipts

3. Unpacking

After unpacking the unit, check that all the necessary accessories are included in the package.

User's Manual	1 PCS
Printer	1 PCS
Data Cable	1 PCS
Power Adapter (include power cord)	1 SET

4. Features

- * 250mm/sec high-speed printing
- * Support Kitchen Printing and Ethernet Printing
- * High print quality
- * Low working noise
- * Support cashdrawer kick-out
- * Easy maintenance
- * Various interface available (Parallel, Serial, USB, Ethernet)
- * Built-in data buffer
- * Support character enlargement, bold, underline, line spacing and character spacing
- * Support NV images download
- * Low energy consumption and low operation cost
- * Compatible with ESC/POS command set
- * Character per line and character set can be set by DIP switches
- * Support Ethernet Printing status monitor, multiple connection printing and OPOS printing
- * Support printer identification, software binding and high-speed driver mode
- * Support various character sets (include GB18030)
- * Support paper end detection

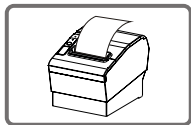

Support paper end detection



High-speed Printing



Printer Identification

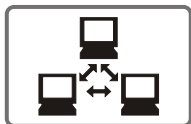

Multiple Connection Printing



OPOS Driver



Various Character Sets

5.Specifications

Model	3250II
Paper end detection	Support
Printing speed	250mm/sec
Paper roll	Dimension: width: 79.5±0.5mm Max diameter: 83mm Roll diameter: Inside: 12mm Outside: Minimum 18mm Maximum 26mm
Printing width	79.5±0.5mm
Dot pitch	576dots / line&512dots / line
Character size	ANK Character, Font A: 12×24dots, Font B: 9×17dots, Chinese Character: 24×24dots
Print command	Compatible with ESC/POS
Interface	Parallel/Serial/Ethernet/USB
Auto cutter	Full or Partial
Reliability print	100Km
Barcode mode	UPC-A/UPC-E/JAN13(EAN13)/JAN8(EAN8)/ CODE39/ITF/CODABAR/CODE93/CODE128
Paper thickness	0.06~0.08mm
Powersupply	DC 24V/2.5A
Power adapter	Input: AC110V~220V, 50~60HZ Output: DC 24V/2.5A
Cash drawer	DC 24V/1A
Work temperature	Temperature: 0~45℃, Dampness: 10~80%
Storage temperature	Temperature: -10~60℃, Dampness: 10~90%
Dimensions	200×142×142MM(W×D×H)

6. Printer Connection

- a. Plug the DC cord connector into the printer's power connector.
- b. Plug the data cable connector into the printer's interface connector.
- c. Plug the drawer cable into the drawer kick-out connector on the back of the printer next to the interface connector.

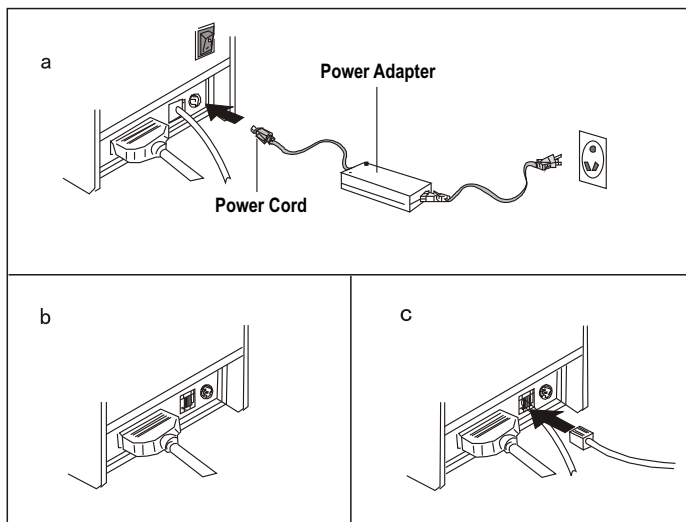

7. Installing the roll paper

- a. Open the printer cover.
- b. Install the roller in the roll paper, and put them into the printer.
- c. Pull out some paper outside the printer and then close the printer cover.
- d. Close the top cover. Press the printer cover to avoid error position of roll paper.
- e. Tear-off the paper correctly.

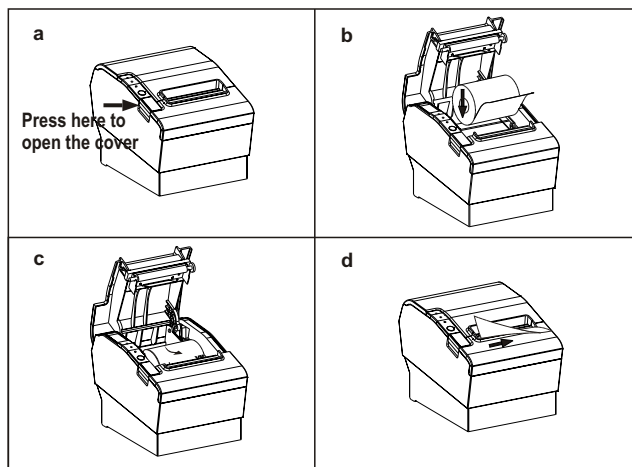

8. Setting the Printing Mode (DIP switches)

The DIP switches are used to set the printer to perform various functions, such as cutter mode, character set, speed, beeper, print density and etc.

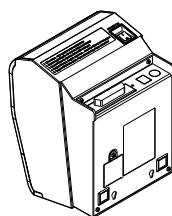

1. Remove the DIP switches cover on the bottom of the printer.

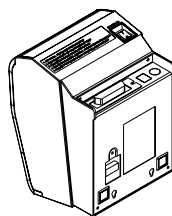
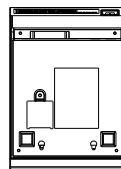

2. DIP switches setting.

DIP SWITCH SETTINGS
BAUDRATE SETTINGS

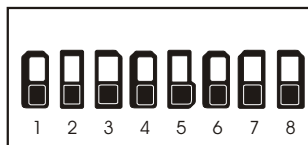

9. Printer Installation

a. Flat Printing

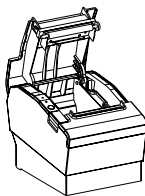
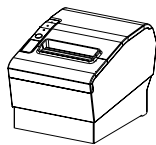

b. Stand Printing

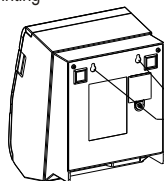

Remove the bottom cover, there are two holder for wall mounting.

10. Printer View

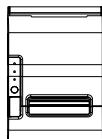

Top View

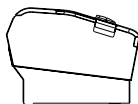

Side View

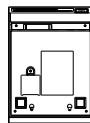

Bottom View

11. Buttons and Indicators

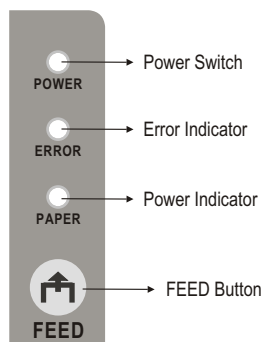

12. Functions of buttons and indicators

(1) . FEED Button

Press to feed paper manually.

(2) . PAPER Indicator

When this indicator is lighting as well as the ERROR indicator, printer is out of paper.

When this indicator is dim as well as the ERROR indicator, printer has paper.

When this indicator is lighting but the ERROR indicator is dim, roll paper is near end.

(3) . POWER Indicator

When this indicator lights, the printer is turned on.

When this indicator dims, the printer is turned off.

(4) . ERROR Indicator

When printer is in the status of paper out, cutter error or print head overheat, this indicator is flashing according to user's defined setting.

13. Cutter Maintenance

Step (1)

- a. Turn off then on the printer, the printer will initialize and reset the cutter.

Step (2)

- a. Open the front cover.
- b. Wheel the gear on the cutter to make the cutter back to initial position. Open the printer cover and install roll paper correctly, then the printer works normally.

⚠ Caution: Do not open the printer cover by force, so as not to damage the print head and auto cutter.

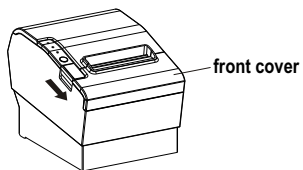

1. The front cover is on the top of the printer

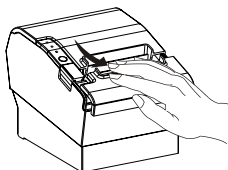

2. Open the front cover by the arrow direction

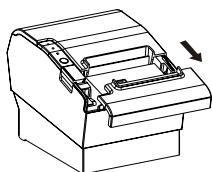

3. After the front cover is opened

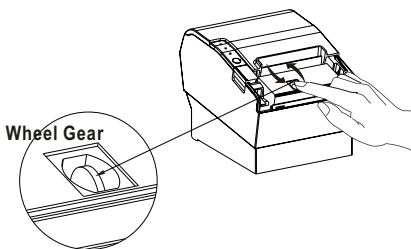

4. Turn the gear to reset the cutter

14. Professional Functions

- a. 250mm/sec high-speed printing
- b. Support Kitchen Printing, Ethernet Printing, and various interfaces
- c. Support paper end detection

 **WARNING:**

All rights reserved. No part of this publication may be reproduced, stored in a retrieval, or transmitted in any form or by any means, electronic, mechanical, photocopying, recording, or otherwise, The company reverses the rights of modifications of manufacture technology, assembly, software and hardware without notice. Contact your franchiser if you need further information about the product.